

► Lamelle Slats

- Lama 65 - *Slat 65*
- Spessore 0,47 mm - *Thickness 0.47 mm*
- Verniciatura su entrambi i lati - *Painted on both sides*

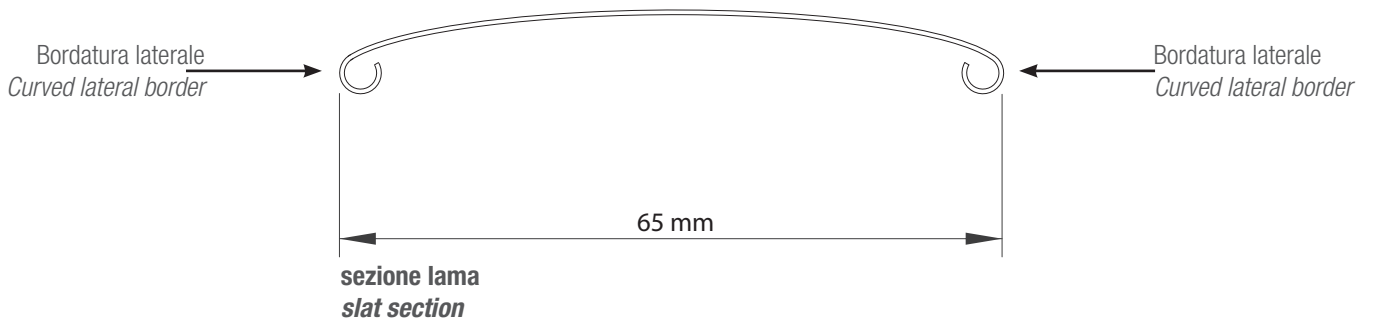

► Texband di trazione texband for blind movement

- Spessore 0,34 mm
- Colore grigio
- Alta resistenza e durata, testata con 100.000 cicli
- Rivestimento con filamenti in Kevlar
- *Thickness 0.34 mm*
- *Grey colour*
- *High resistance and long-lasting quality, tested with 100.000 cycles*
- *Covered with kevlar fibers*

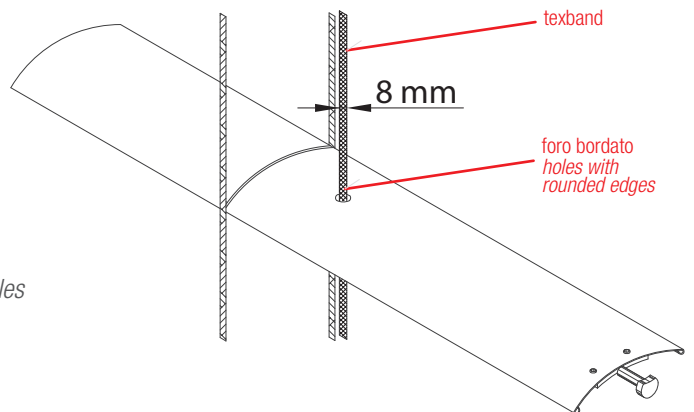

► Scaletta di orientamento Ladder string for slat tilting

- Scaletta di orientamento che avvolge la lama
- Colore grigio
- Materiale in poliestere rafforzato con fili in aramid
- Rivestimento con filamenti in Kevlar
- *Ladder string for slat tilting*
- *Grey colour*
- *Polyester material covered with aramid fibers*
- *Coated with kevlar fibers*

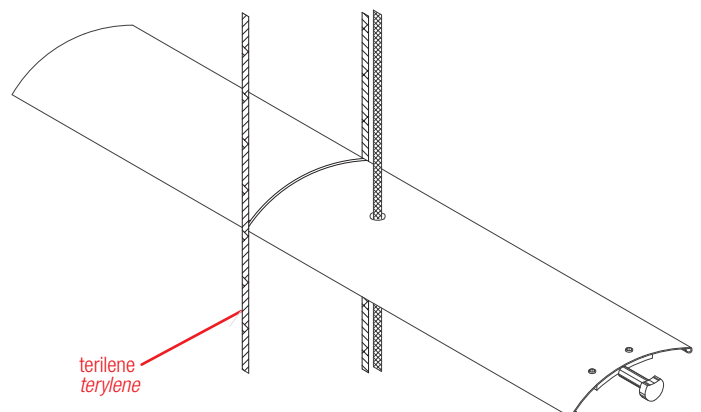

► Clip in acciaio - Piolo - Foro per guida cavo steel clip, hook, hole for cable guide

L'aggancio tra terilene e variatore avviene tramite CLIP in acciaio INOX A2
Terylene and tilter are connected through a CLIP in stainless STEEL A2

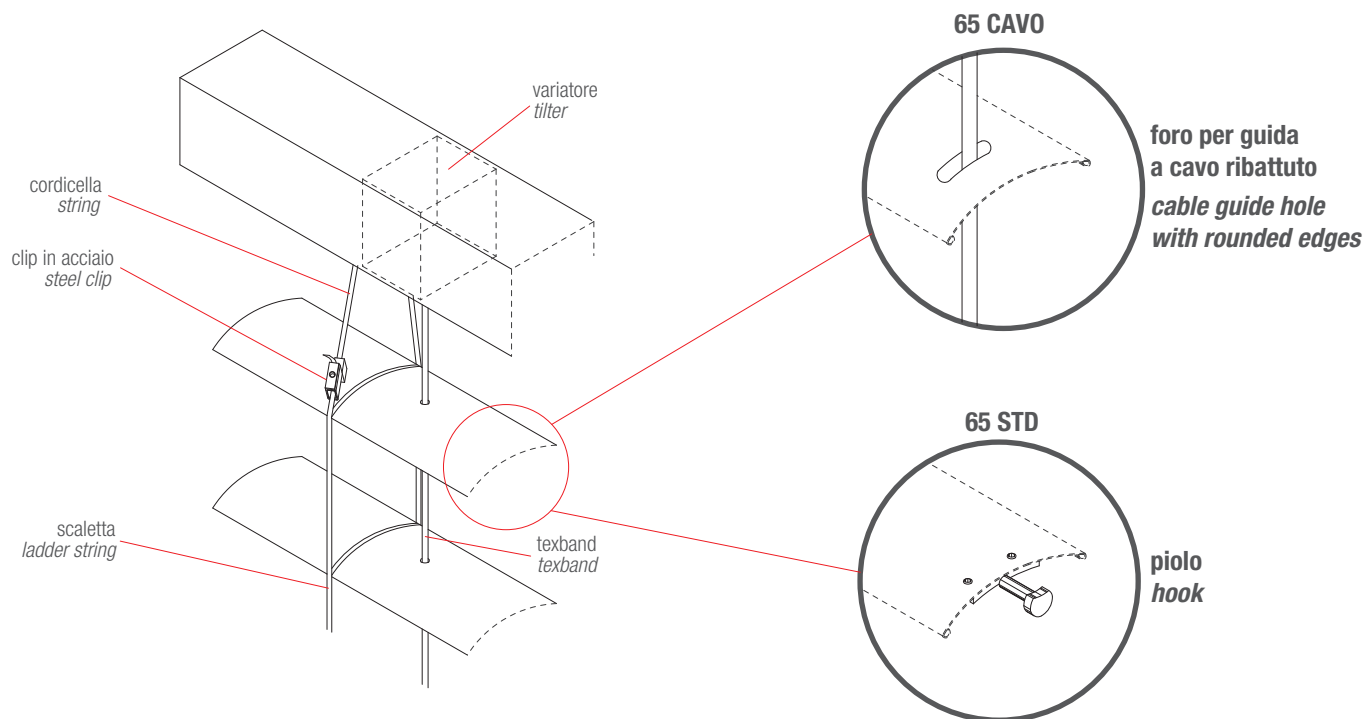

► Canale di manovra 56x58 head rail 56x58

Canale in acciaio zincato o zincato con verniciatura di spessore 6/10
Head rail in galvanised steel or painted with thickness of 6/10

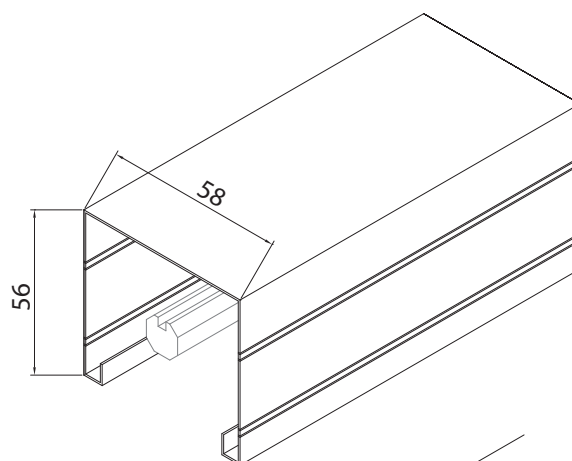

► Terminale e Tappo bottom rail and cap

Terminale in alluminio estruso anodizzato o verniciato di spessore 13/10 completo di tappi telescopici.
Bottom rail in extruded aluminium, anodised or painted with thickness of 13/10 and telescopic caps.

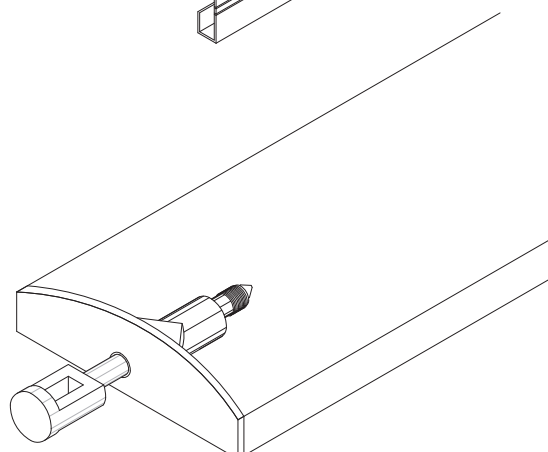

► Guide Modello 65 CAVO 65 CABLE guides type

Guida in acciaio ricoperto in PVC Ø 3 mm - Steel cable guides covered with PVC Ø3 mm

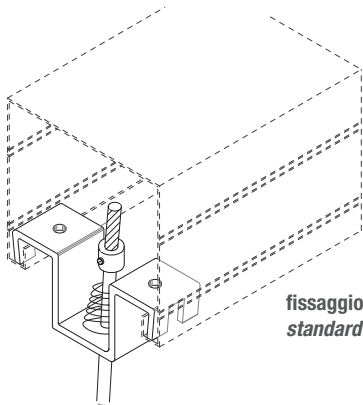

ancora per fissaggio guida al canale di manovra

holder for cable guide fixation at head rail

fissaggio standard se non diversamente specificato
standard installation if not otherwise requested

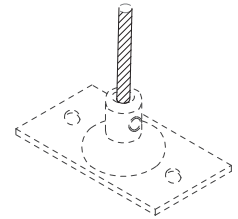
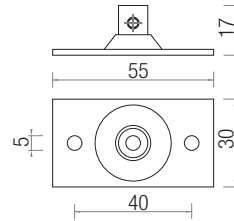

guida fissata con piastrina a terra
cable guide fixed on ground through base plate

► Supporto in nylon Modello 65 STD holder in nylon for 65 STD type

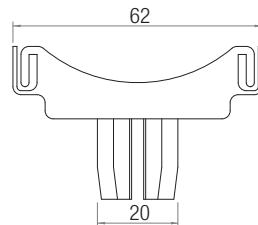
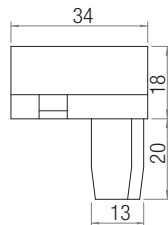
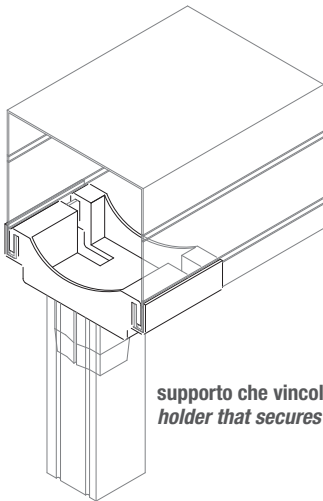

supporto che vincola la guida al cassonetto nel suo interasse
holder that secures the rail guide to the head box in its centreline

► Guide Modello 65 STD rail guide types for 65 STD

Guida in alluminio estruso anodizzato o verniciato completa di guarnizione antirumore
extruded aluminium rail guides, anodised or painted, with rubber profile for noise reduction

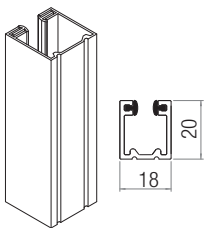

*Guida singola
Standard rail guide

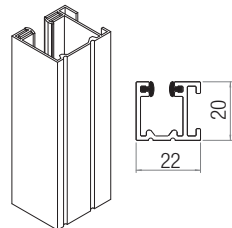

*Guida singola per distanziale
Standard rail guide for telescopic holder

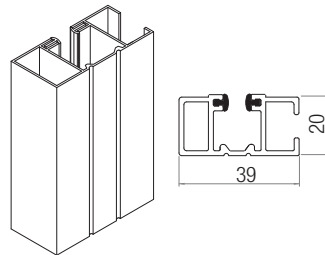

Guida autoportante
Self-supporting rail guide

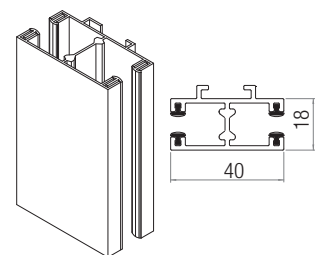

Guida doppia
Double rail guide

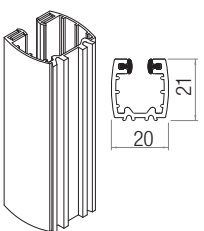

Guida singola round
Rounded single rail guide

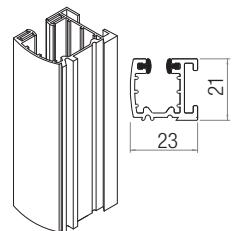

Guida singola round per distanziale - Rounded
single rail guide for telescopic holder

Guida singola ad incasso
Single embedded rail guide

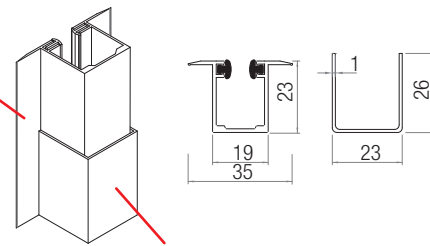

Canalina
Mounting profile

*Guide fornite su richiesta - *rail guides supplied upon request